

男子団体

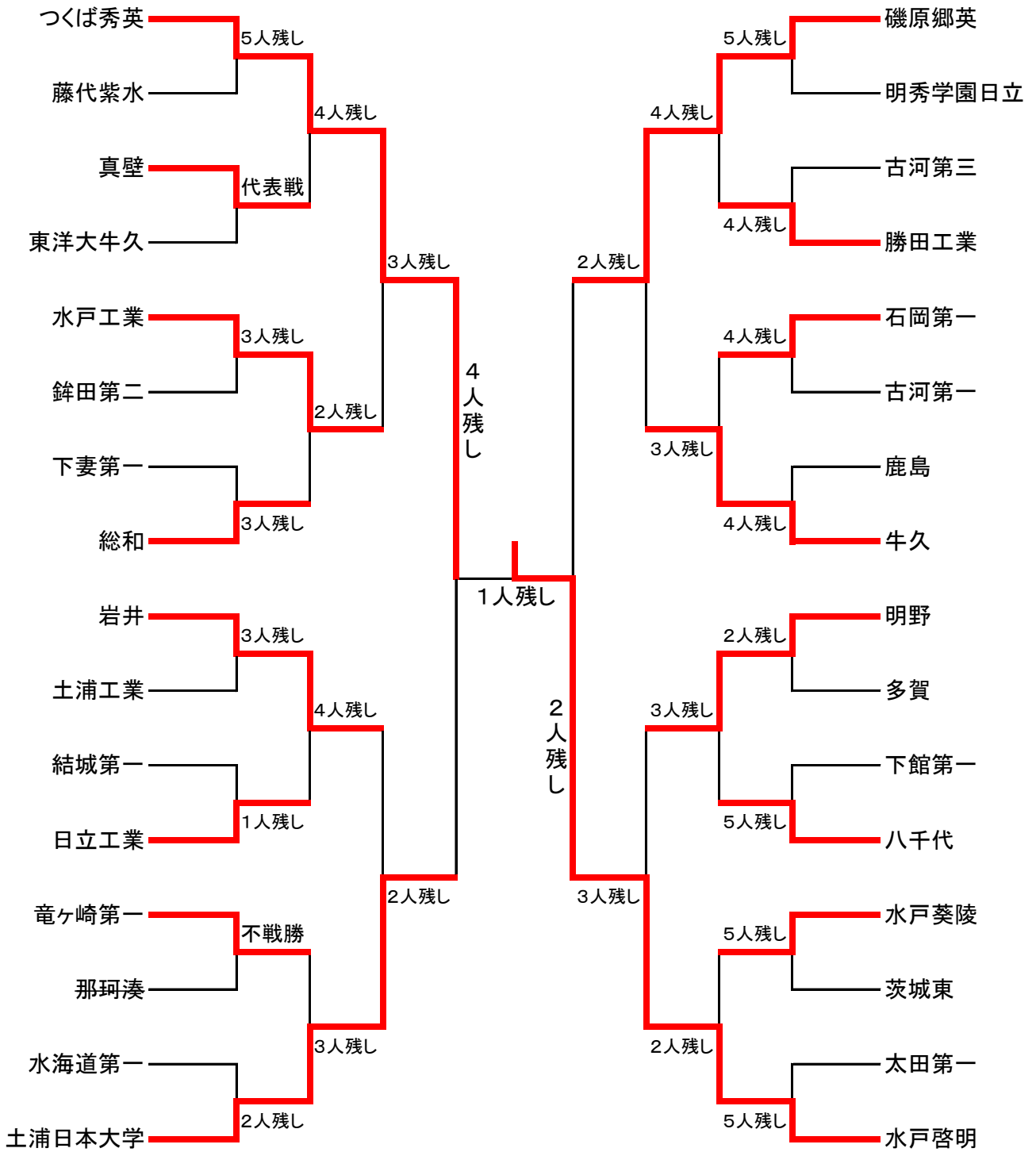

3位決定戦

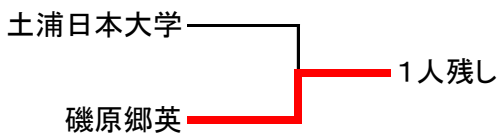

男子60kg級①

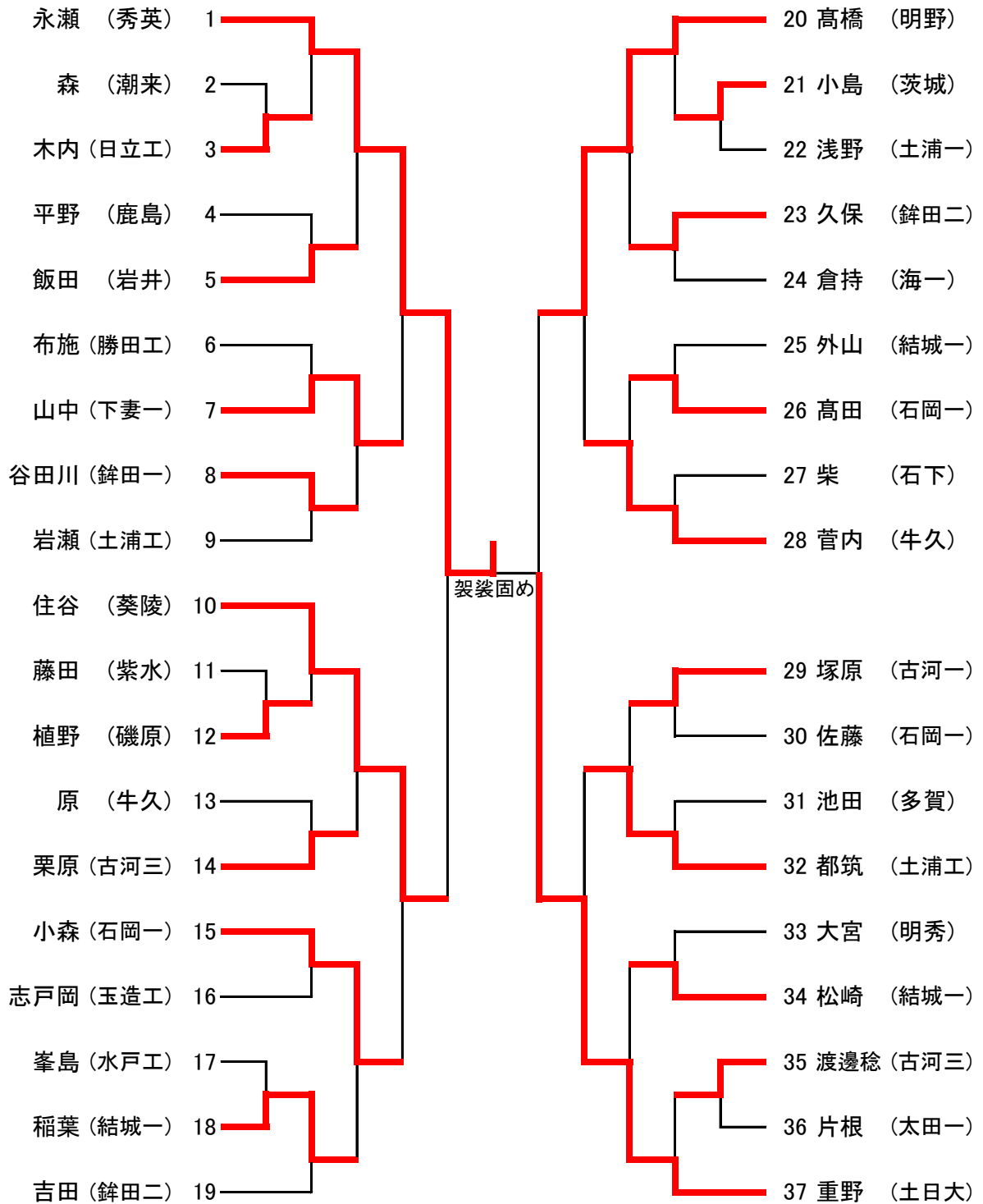

決勝戦

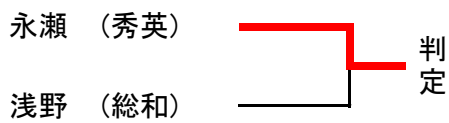

男子60kg級②

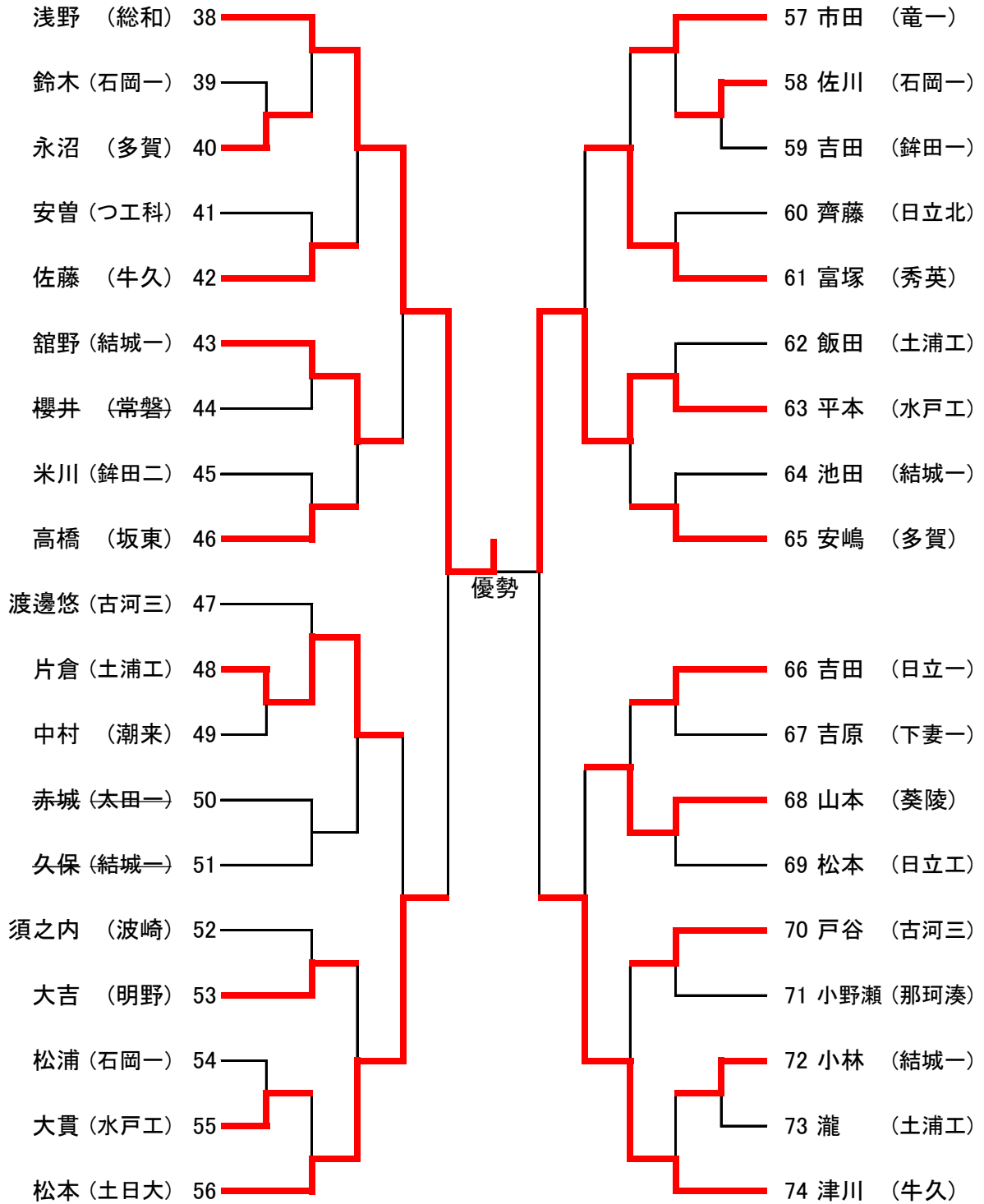

男子73kg級①

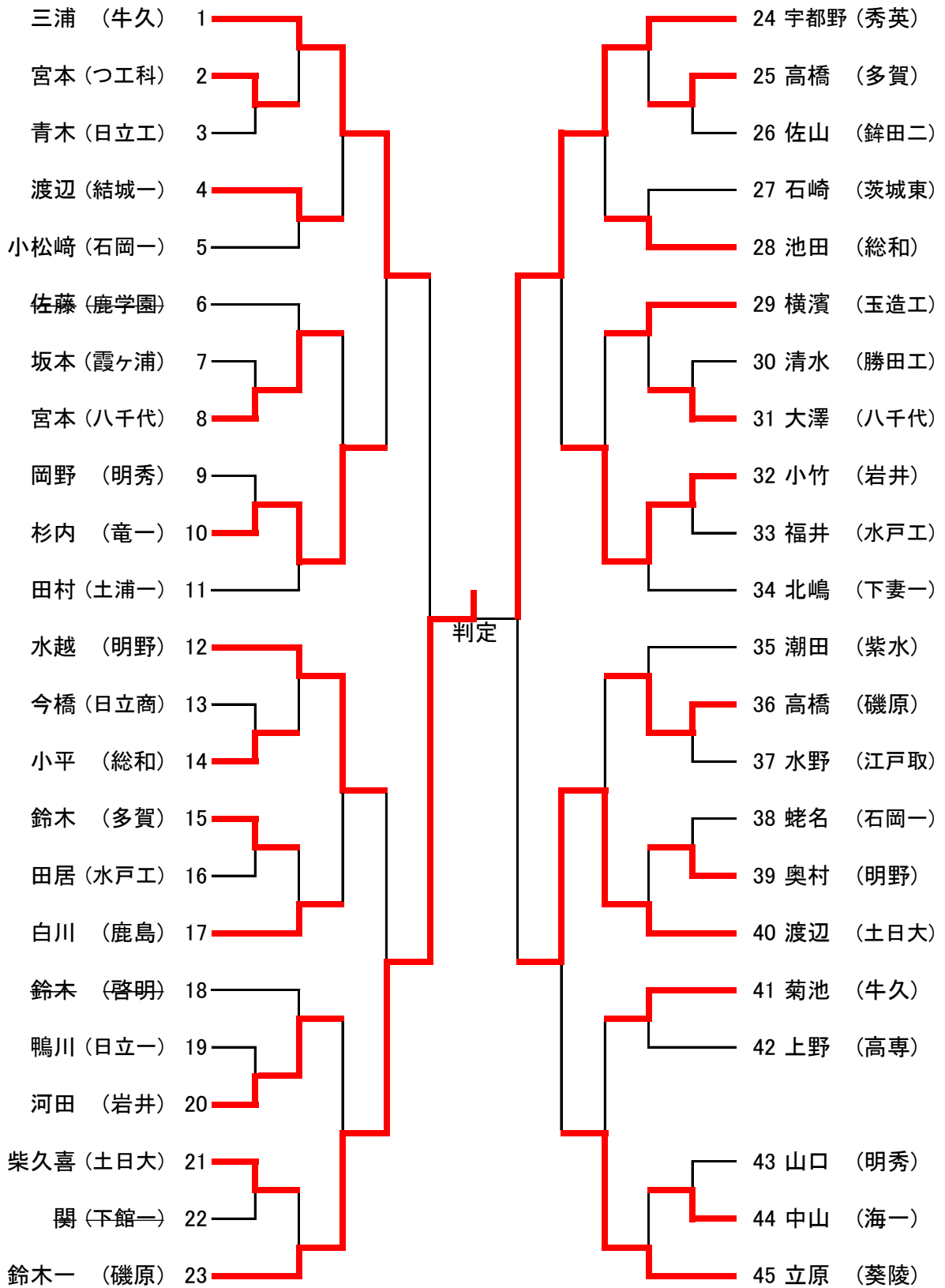

決勝戦  
 鈴木一 (磯原) — 小外  
 羽成 (土日大) — 刈り

男子73kg級②

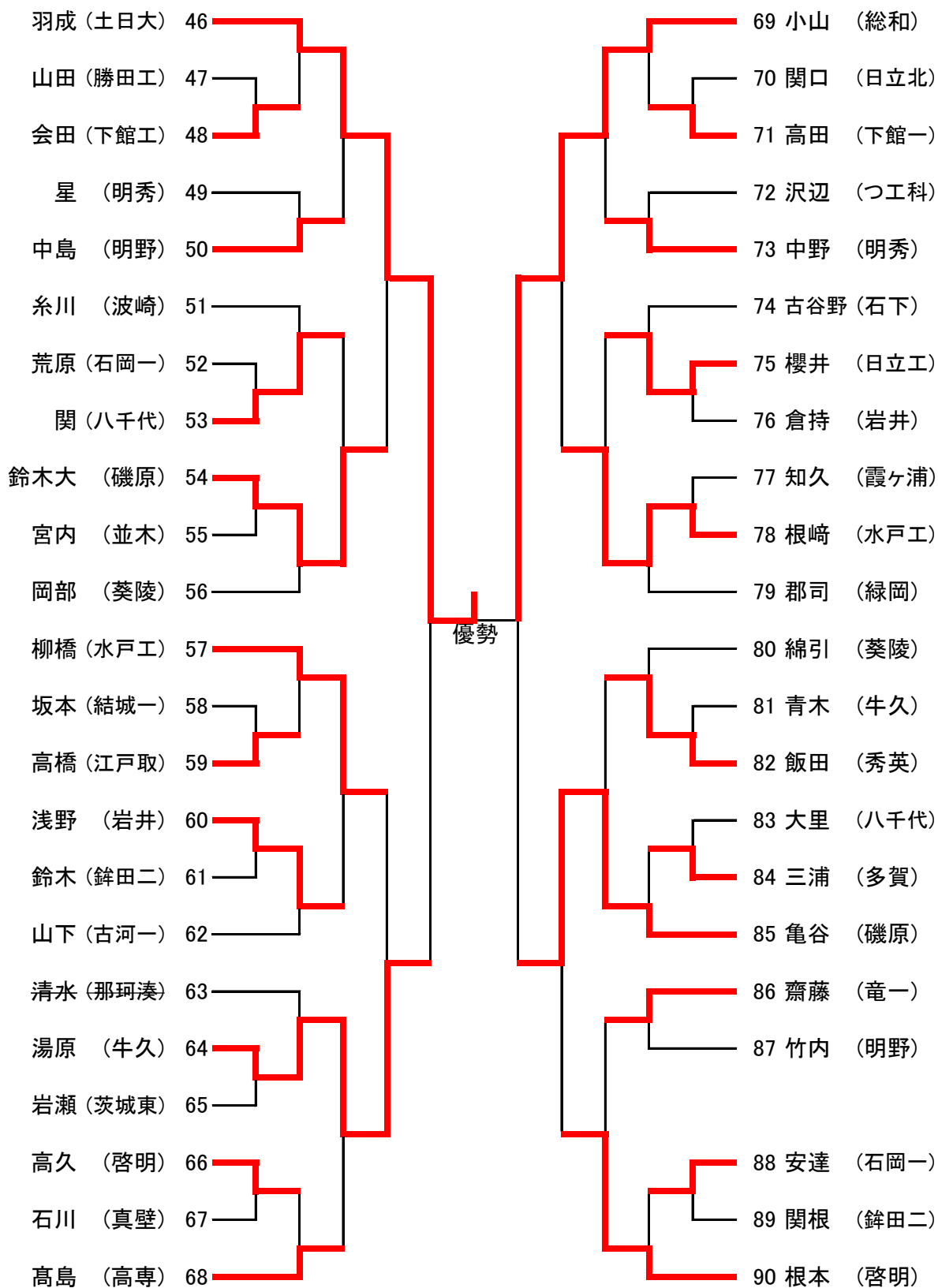

男子81kg級

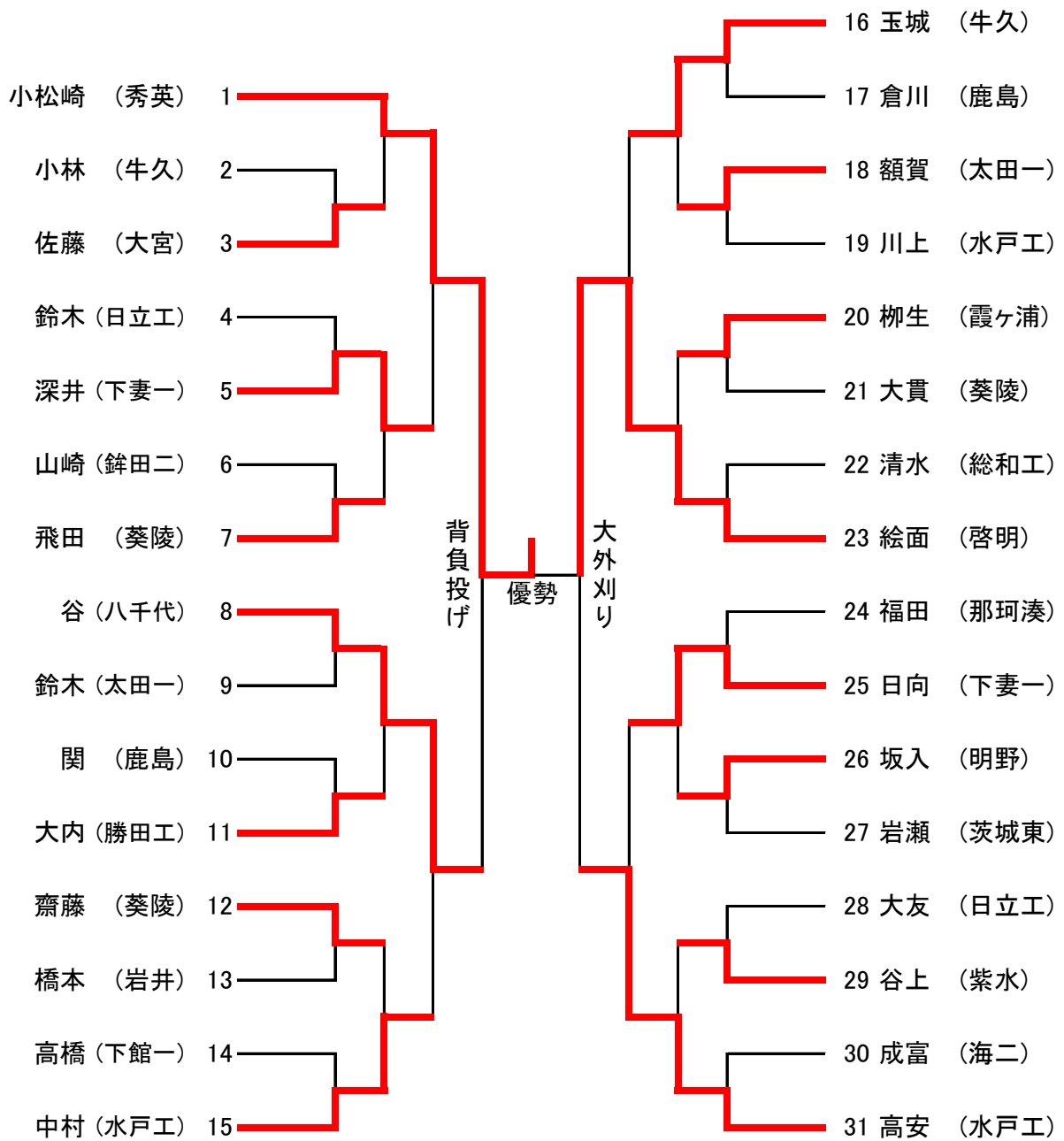

男子90kg級

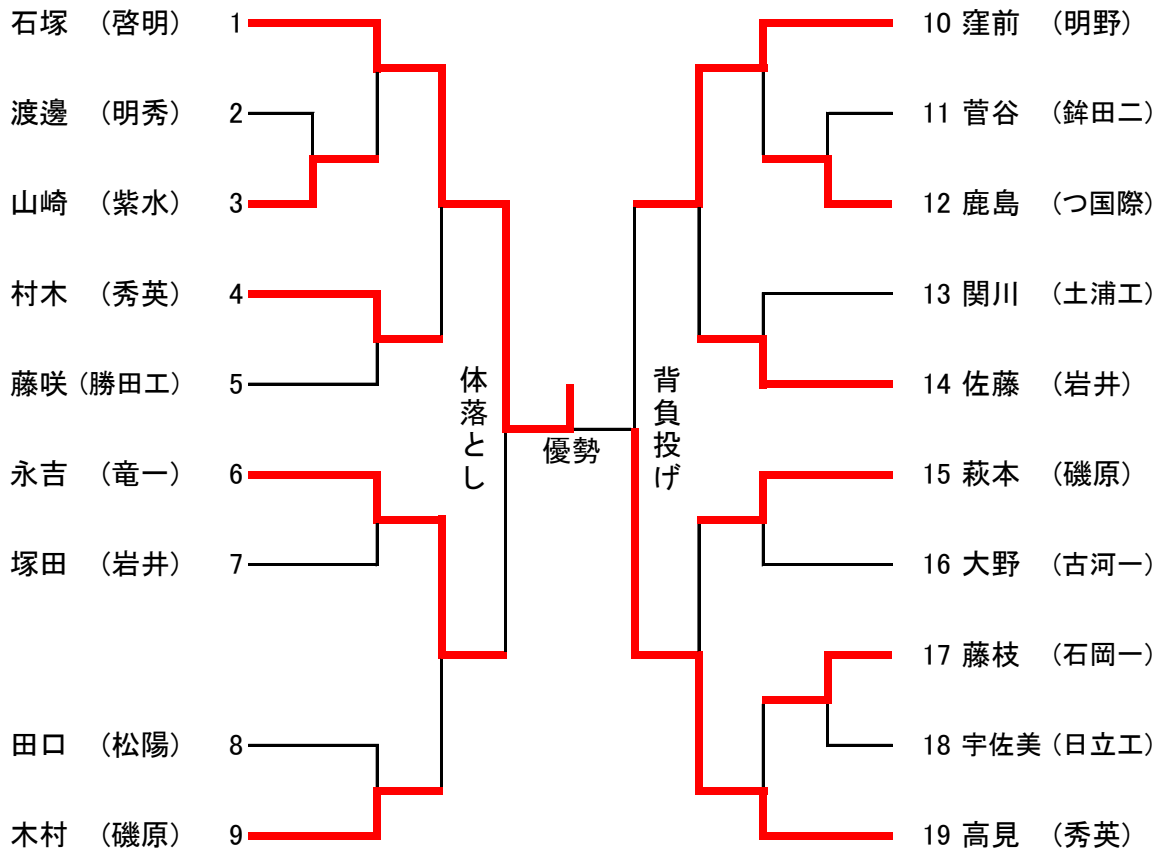

男子無差別級

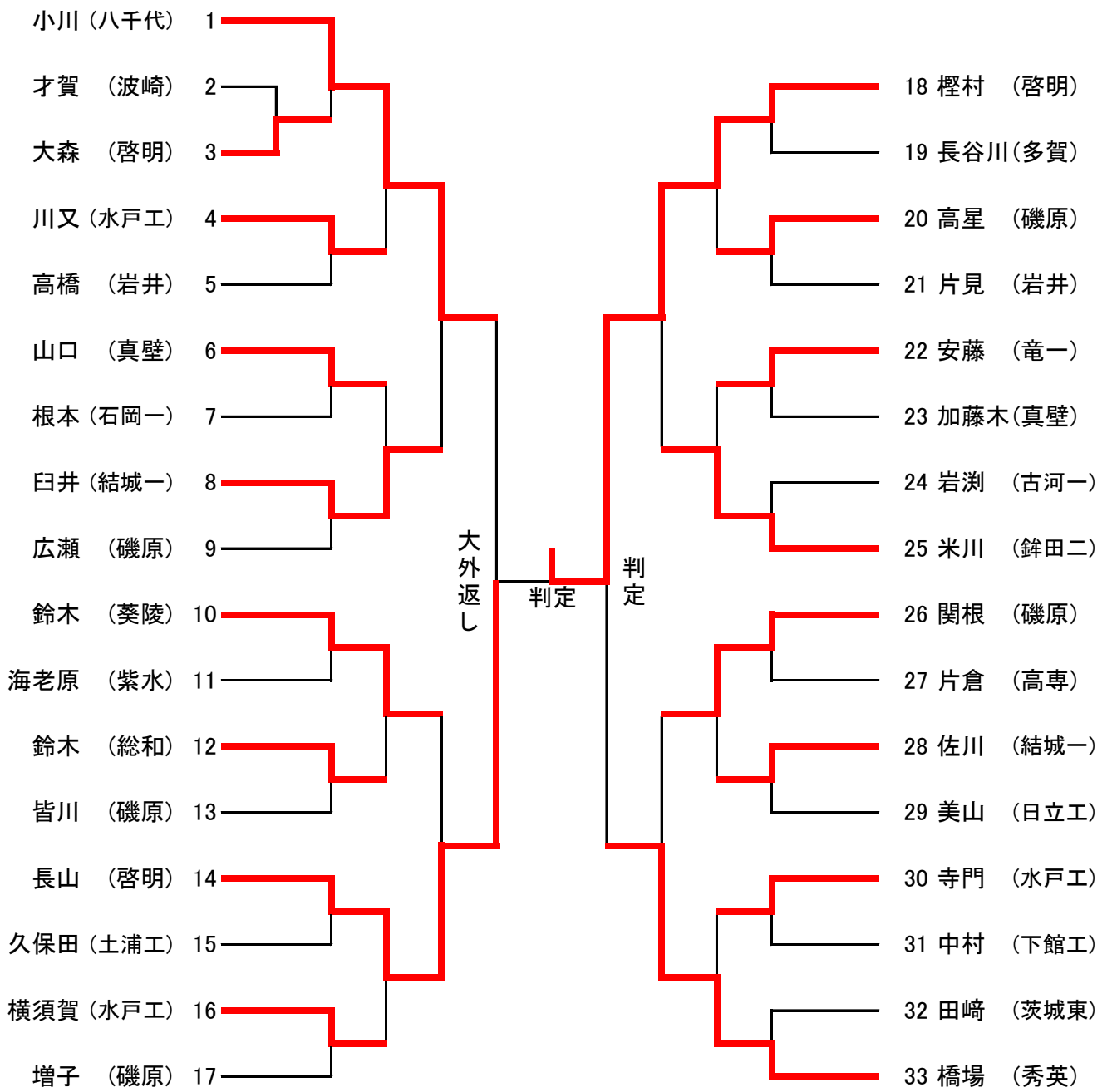



女子団体

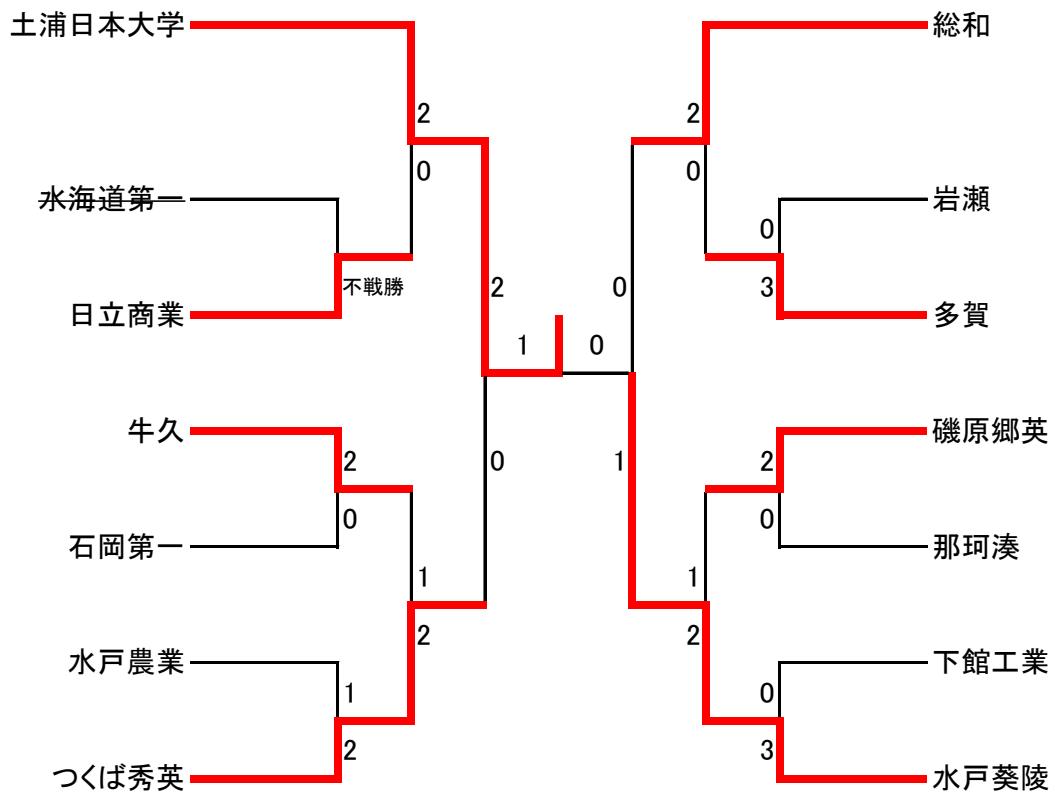

3位決定戦

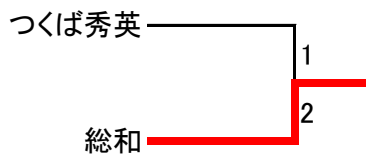

女子52kg級

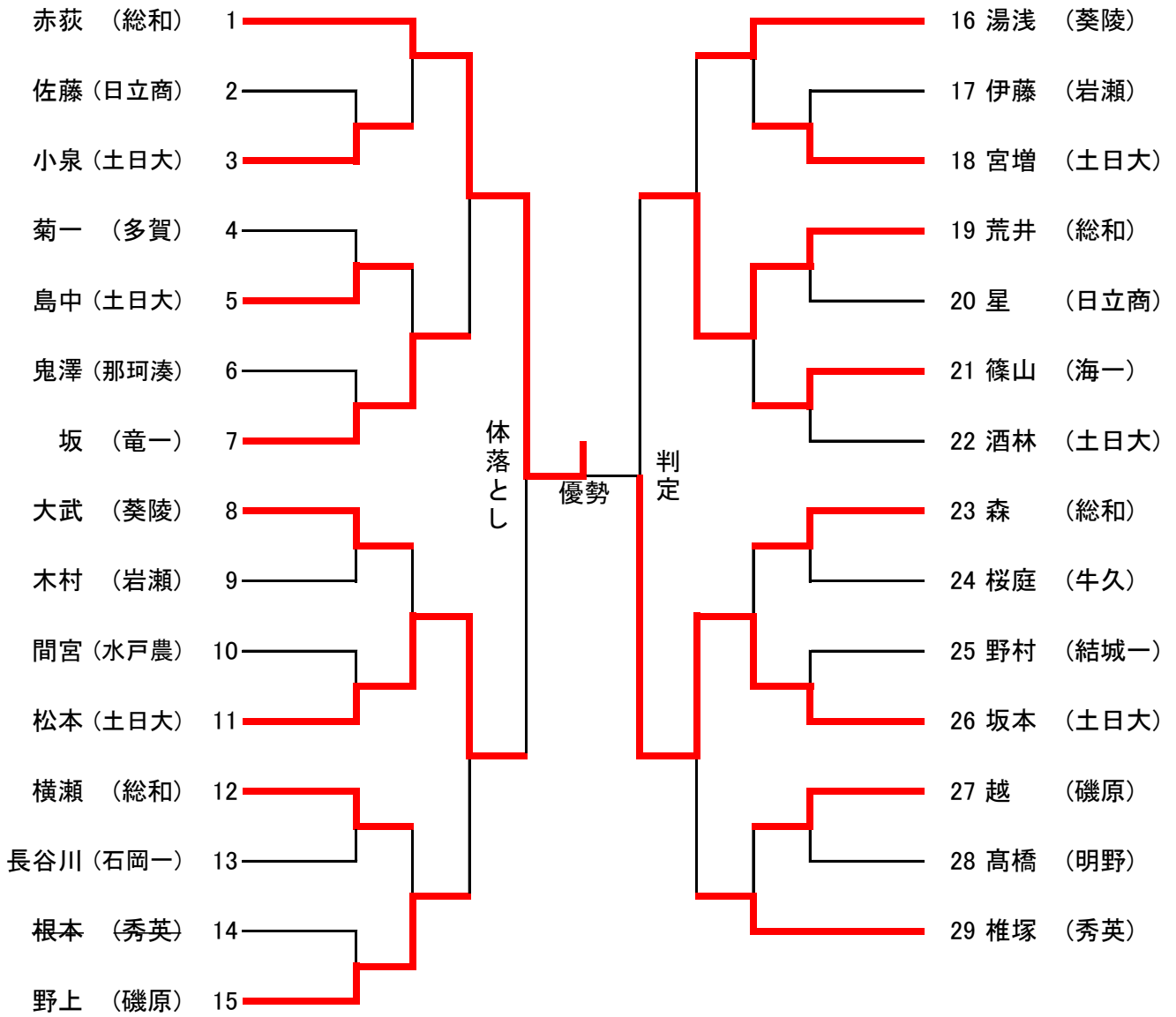

女子57kg級

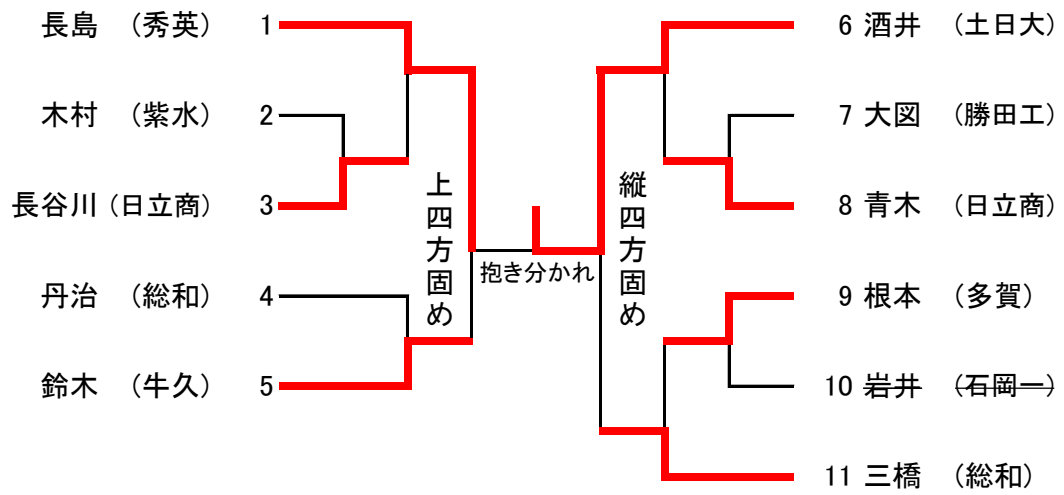

女子63kg級

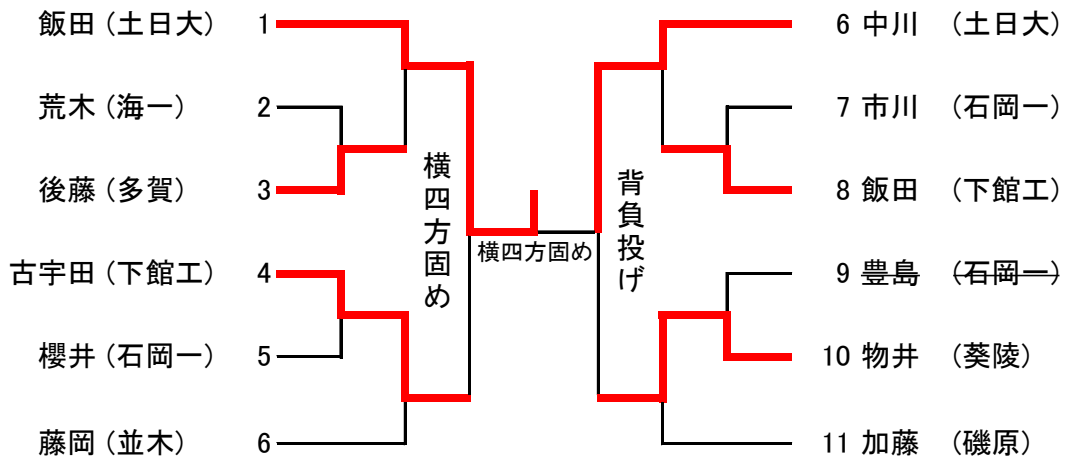

女子70kg級

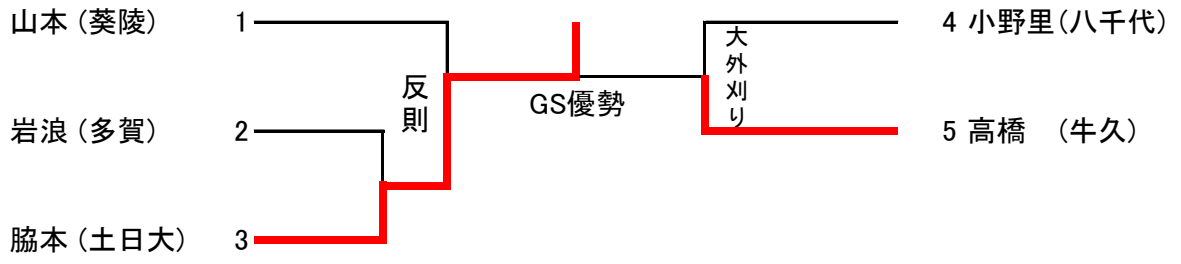

女子無差別級

